



ENIB Co.,Ltd.

# MASTER<sup>®</sup> LOCK FITTING

UNION TYPE[PATENT NO. : 10-1842173] MASTER<sup>®</sup> LOCK  
[REGISTRATION NO. :40-1790304]

## OVERVIEW

The UNION FITTING is widely used on main and Sub line PFA pipings that connect with CCSS and WET equipment due to its safe design structure.

## FEATURES

1. Enhanced airtightness due to multiple seal design structure (1st-Primary, 2nd-Back up, 3rd-Joint Seal, 4th-Grip Seal)
2. Reduction in equipment size possible with minimized design configuration
3. Addition of locking device to prevent loosening of PFA nut

## TECHNICAL DATA

Port Connection	E&IB Ferrule Connection
Port Size	1/4", 3/8", 1/2", 3/4", 1", 1-1/4", 1-1/2", 2"

Operating Temperature	Operating Temperature (1/4"~1-1/4")	Operating Temperature (1-1/2"~2")
0 ~ 90 ℃	9kg/cm <sup>2</sup> (0.9Mpa)	7kg/cm <sup>2</sup> (0.7Mpa)
90 ~ 120 ℃	7kg/cm <sup>2</sup> (0.7Mpa)	5kg/cm <sup>2</sup> (0.5Mpa)
Over 150 ℃	Below 5kg/cm <sup>2</sup> (0.5Mpa)	Below 3kg/cm <sup>2</sup> (0.3Mpa)

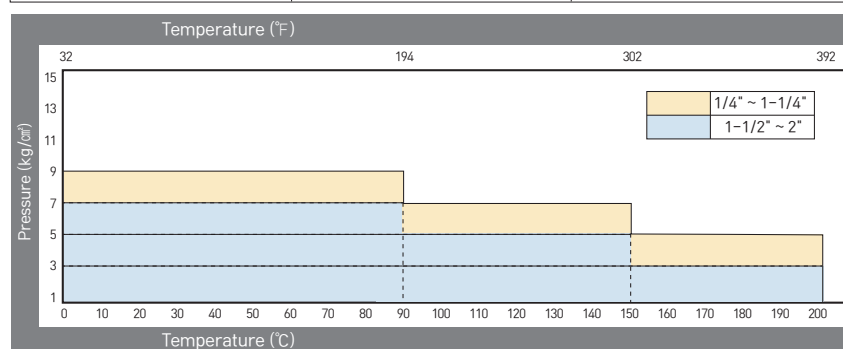



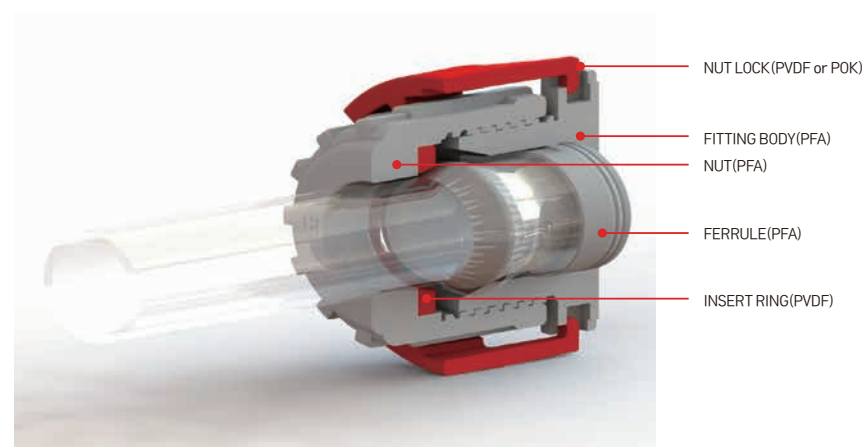



## MATERIAL CONSTRUCTION

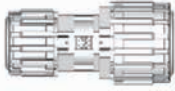
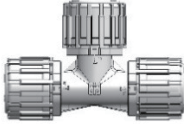
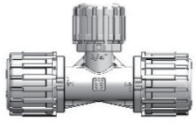







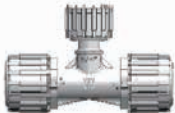

Extrusion & injection, basic

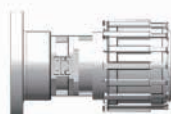
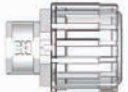

A Tube to Tube				
Type	UNION STRAIGHT	UNION REDUCER	UNION TEE	UNION RED TEE
				
Part No.	UF-US	UF-UR	UF-UT	UF-URT
Type	UNION ELBOW	UNION RED ELBOW	PANNEL MOUNTING UNION	
				
Part No.	UF-UE	UF-URE	UF-PMU	

B Tube to Male or Female tube thread			
Type	MALE CONNECTOR	MALE ELBOW CONNECTOR	FEMALE CONNECTOR
			
Part No.	UF-MC	UF-MEC	UF-FMC

C Space Saver				
Type	SPACE SAVER ADAPTOR	SPACE SAVER UNION TEE	SPACE SAVER UNION ELBOW	ELBOW TUBE ADAPTOR SAVER
				
Part No.	UF-SSA	UF-SSUT	UF-SSUE	UF-ETAS

D Others				
Type	TUBE ADAPTOR	ELBOW TUBE ADAPTOR	UNION FLANGE ADAPTOR	TUBE END CAP
				
Part No.	UF-TA	UF-ETA	UF-UFA	UF-TCAP
Type	END CAP	NUT	FERRULE	
				
Part No.	UF-UCAP	UF-NUT	UF-FRUL	

## MULTIPLE SEAL STRUCTURE

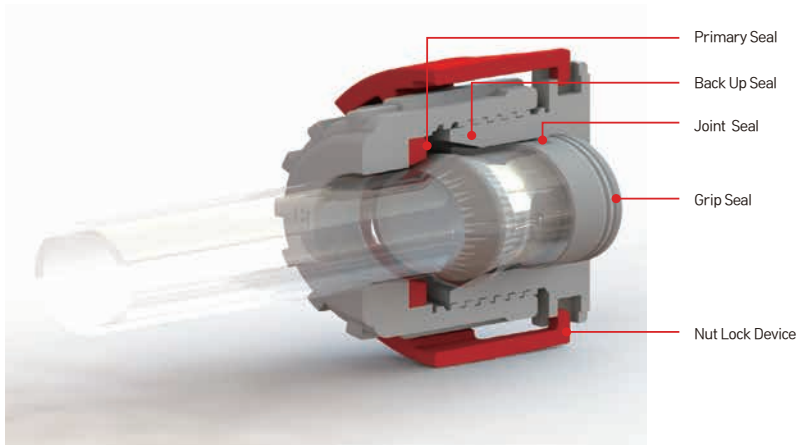

## HOW TO ORDER

Product Name	CODE	Code_Shape	CODE	SIZE	CODE
UNION FITTING	UF	UNION TEE	UT	1/4"	04
		UNION STRAIGHT	US	3/8"	06
		UNION REDUCER	UR	1/2"	08
		UNION RED TEE	URT	3/4"	12
		UNION RED ELBOW	URE	1"	16
		UNION FLANGE ADAPTOR	UFA	1-1/4"	20
		UNION ELBOW	UE	1-1/2"	24
		TUBE END CAP	TCAP	2"	32
		TUBE ADAPTOR	TA	15A	15
		SPACE SAVER UNION TEE	SSUT	20A	20
		SPACE SAVER UNION ELBOW	SSUE	25A	25
		PANNEL MOUNTING	PMU	40A	40
		NUT	NUT	50A	50
		MALE ELBOW CONNECTOR	MEC		
		MALE CONNECTOR	MC		
		FERRULE	FRUL		
		FEMALE CONNECTOR	FMC		
		END CAP	UCAP		
		ELBOW TUBE ADAPTOR	ETA		
		ELBOW TUBE ADAPTOR SAVER	ETAS		
SPACE SAVER ADAPTOR	SSA				

Example : UF - UT - 08

UF	UNION FITTING
UT	UNION TEE
08	1/2"

### “ SMART VALUE OPERATION PRODUCT LINE UP ”

#### E&IB (Extrusion & Injection, Basic Co., Ltd) Corporate Mission :

E&IB is to become a key provider of safe, high performance, and advanced technology device and components for fluid management systems and applications that meet or exceed the needs and requirements of global customers.

65-59, Ucheonje2nongongdanji-ro, Ucheon-Myeon,  
Hoengseong-gun, Gangwon-do, Republic of Korea  
Customer Service Tel : +82 033 345 8836  
Customer Fax : +82 345 8837  
www.enib.co.kr